

Warranty

▶ **To receive after service, have the following ready before you contact our branches.**

1. Name of the product.
2. Model number of the product.
3. The area of problem.
4. Phone number and address at which you can be contacted.

Warranty Card

PRODUCT	
MODEL	
DATE PURCHASED	
WARRANTY PERIOD	
AGENCY ADDRESS	

▶ **KOCOM Warranties the original purchaser of this product as follows.**

- 1) This product is produced under strict quality control and inspection procedures.
- 2) If this product breaks down during proper use as a result of product defect, KOCOM will repair it within one year from date of purchase free of charge.
- 3) The following cases will be subject to charge, even during warranty period:
 - a. Breakdown during transport, or through careless treatment, by consumer.
 - b. Breakdown cause by unauthorized repair, or system modification.
 - c. Breakdown caused by natural disaster or power disorder.



<http://www.kocom.com>

E-mail : export@kocom.co.kr

This manual is based on the date as shown in the right and specifications are subject to change without notice for quality improvement

KVL/KEL Series 2wire 09.09

Common Gate Camera

[KVL-C202i / KVL-C203i / KVL-C204i / KEL-212]

- Automatically opens common gate while communication with house
- For 2 wire type videophone
- Keypad backlight function - LED lamp
- White LED for night detection
- Camera angle control
- Connecting upto 40 household
- Opening function of entrance door using I -button key
- Function of door release without adaptor
- Function of two door release type(NO, NC)



KOCOM CO.,LTD.







Warnings & Cautions for Safety

For safe use, please stick to the following cautions.

- Read this cautions carefully and keep it within easy reach of you.
- For right installation, read this cautions thoroughly. Please install the product according to its specifications.
- This Cautions for Safety may include items that are not contained in specifications of the product that consumer purchases.
- Reading this cautions, use the product in a right manner. For further information, please contact our A/S center.

About symbol

A variety of symbols are used in this Cautions for Safety and your products to guide you to use products in a right and safe manner and to prevent possible risks for users and other persons and damages to their property. The meaning of each symbol is as follows. After fully aware of meaning of each symbol, read the following cautions.

-  This symbol means that wrong handling or ignorance of matters that this symbol indicates may cause serious injury or even death of user.
-  This symbol means that wrong handling or ignorance of matters that this symbol indicates may cause serious injury or property damage of user.
-  This symbol means the matter that user should not do at any event.
-  This symbol means that user should follow the instructions.
-  This symbol means that contents (high voltage, electric shock, warnings, etc.) to which user should pay attention are included.
-  This symbol means that a certain action is not permitted. Specific points not permitted are depicted around this symbol (for example, in the left drawing, disassembly is not permitted.).
-  This symbol means instructions or is used to force user to do a certain action. Specific instructions are depicted on the drawing (for example, the left drawing instructs user to detach power plug from an outlet).









Warnings

Warnings for disposal

-  Do not throw used-up battery into fire places, which may cause fire and explosion.

Cautions







Cautions for installation

-  The relevant law obliges users to have a qualified electrician carry out wiring work for power supply. Work by disqualified persons may cause fire and electric shock.
-  Wiring work for communication cables need techniques and experiences. For this type of wiring work, please consult to your local sales agent.
-  According to the standard for electric work and other relevant regulations, install communication cables at the place away from power cables. The failure to install cables separately may cause fire, electric shock and communication troubles.
-  Do not install the product on rolling table or sloping place. Dropping or falling may cause damage on your product.
-  In installation, avoid the place exposed to tremor or shocks, which may cause damages on your product.
-  Even if your product is waterproof, do not install it slanted place of water leakage, which may cause a short circuit.
-  For the product of wall-mounting type with fixing pegs, keep it safely. Fixing pegs may cause injury of user.
-  Install the product of wall-mounting type carefully not to drop from the wall. Dropping due to earthquake or tremors may cause injury of user.
-  When installing the product on the wall, consider the thickness and material of the wall. Dropping in use may cause injury of user.

Cautions for use

-  Do not put heavy thing on the product. Dropping or falling due to heavy things on it may cause injury of user.

Cautions for repairs and maintenance

-  Clean the dust inside the product regularly. Failure to clean the dust for long time may cause fire. For inspection and cleaning of the inside of product, please contact your local sales agent.
-  When putting your hands into the inside of equipment, be sure that plug is already detached from an outlet or circuit-breaker is turned off.
-  Be careful not to expose the product to benzene, thinner or hot water.
-  Do not expose detergent directly to the product in a way of spraying, etc.
-  Moving equipment, be sure that the plug is detached from an outlet.
-  For equipment whose cables are connected to terminals, please contact your local sales agent or qualified electrician.
-  When replacing old fuse with new one, do not directly touch it with bare hands. Use insulated tools or contact A/S center.

Warnings

Cautions for use

- Do not install the product at bathroom or at the place near a washing machine, or at other humid places.
It may cause fire or electric shock.
- Do not install the product at the place near a dresser, humidifier or heater. Also avoid the place exposed to spark, heat or humidity. All of them may cause fire and electric shock.
- Do not install the product at the place exposed to dust, metals and harmful gas such as hydrogen sulfide gas.
All of which may cause fire and electric shock.
- Do not install the product at the place exposed to water and chemicals. This may cause fire and electric shock.
- Do not scratch, break or arbitrarily process power cable, which may cause fire and electric shock. Putting a heavy thing on a cable, heating it or pulling it, may cause impairment on it.
- Do not place power cable at the place near heating equipment. It may cause damage of cable's clothing material, which results in fire and electric shock. When detaching plug from an outlet, do not pull power cable.
- Damages on power cable may cause fire and electric shock. When detaching plug from an outlet, please hold the plug tightly.
- Do not detach plug from an outlet with wet hand. It may cause electric shock.



- When using the existing wiring, be sure of the suitability of it to the product and install the product.
Failure to this caution may cause fire.



- When moving equipment, be sure that plug is detached from an outlet and communication cable is disconnected.
Damage on cables may cause fire.



- Voltage other than prescribed rated voltage is not permitted, which cause fire and electric shock.
- Do not use power terminal of product's main body in other equipment than prescribed ones.
It may cause fire and short-circuit.



- In wiring work, use the designated wiring materials.
Wiring work using other materials than designated ones may cause fire.



- The equipment without waterproof marking should not be installed at the place water leaks.
It may cause electric shock and short circuit.
- When working, be sure that power is disconnected. Failure to disconnect power may cause electric shock.



- Be sure that the power cable is connected and earths according to designated method.
Failure to connection and earth may cause fire.



- Do not connect power to other terminals than designated ones.
It may cause fire and electric shock.



- When building a system with the product, do not connect the product to other equipment than designated one.
It may cause fire.



- When installing A/C switch, do work after removing the substance that may cause short circuit or electric shock.
- Before installing or providing A/S service, be sure that the power is disconnected.

Warnings

Cautions for use

- This product is not for perfect security solution.
- Do not handle the equipment with wet hand, which may cause electric shock.
- Do not place wet or metallic materials on equipment. Water leakage or intrusion of metallic materials may cause fire and electric shock.
- Do not block the ventilating opening of equipment or put alien substances into it, which may cause fire and electric shock.
- Do not use battery that is not designated or mix new battery with old ones. Insert batteries to fit their polarity.
Explosion or leakage of battery may cause fire and injury of user.
- When visitor's image or voice is not displayed on screen or not sounded from speaker, please check his/her identity before opening the door and contact our A/S center.
- Do not use equipment when lightning is expected or strokes. It may cause fire and electric shock.
- This product is cannot be used for security.



- Do not open rear cover, cabinet and cover of equipment.
It may cause electric shock.



- Do not modify power cable or pull it with excessive strength, which may cause fire and electric shock.



- Do not modify equipment. It may cause fire and electric shock.
- Call signal may cause damage on user's hearing ability.

Cautions for abnormality

- When power cable is broken (exposure of core or short-circuit), do not fail to replace broken cable with new one.
Failure to replace broken power cable may cause fire and electric shock.
- When detecting any abnormalities in equipment (communication is not available, images do not be displayed on screen, calling is not available, or abnormal sound is heard), immediately detach plug from an outlet, or turn off circuit breaker or detach batteries from equipment (in case that equipment has no plug) before requesting repairs to sales agent or A/S center. Keeping connection to power supply may cause fire and electric shock.
- When alien substances go into equipment, immediately detach plug from an outlet, or turn off circuit breaker or detach batteries from equipment (in case that equipment has no plug) before requesting repair to sales agent or A/S center.
- In the case of smoke or smell of unknown origin from equipment, keeping use it may cause fire and electric shock. Detach plug from an outlet, or turn off circuit breaker or detach batteries from equipment (in case that equipment has no plug) and be sure to check no more smoke or smell from equipment before requesting repair to sales agent or A/S center. Since personal repairing work by user may serious accidents. In any case, do not repair equipment with your own hand.
- When dropping equipment or breaking its cabinet, detach plug from an outlet, or turn off circuit breaker or detach batteries from equipment (in case that equipment has no plug) before requesting repair to sales agent or A/S center.
Keeping use equipment may cause fire and electric shock.
- Avoid direct exposure to sunlight and store equipment at the place free from dust and high temperature as you can. High temperature of equipment may cause fire and electric shock.



Installation

Common gate camera Installation

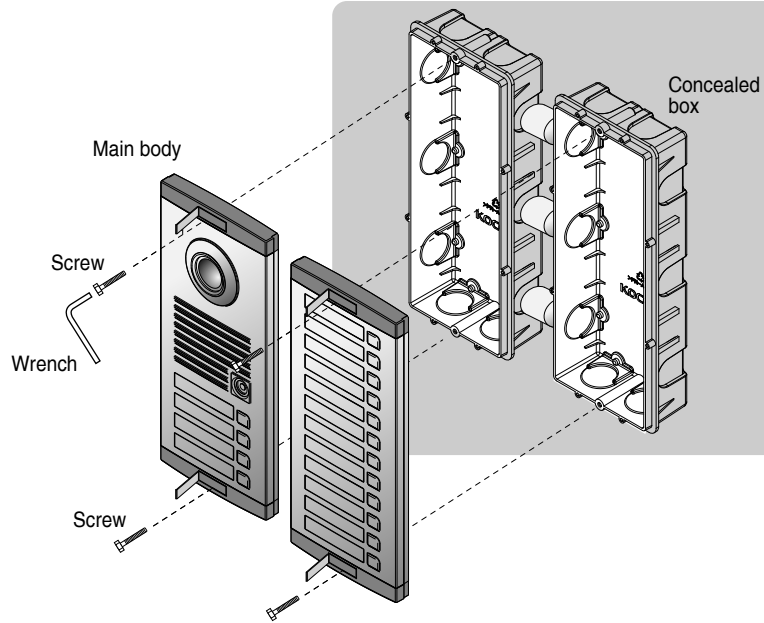

Standard height for installation

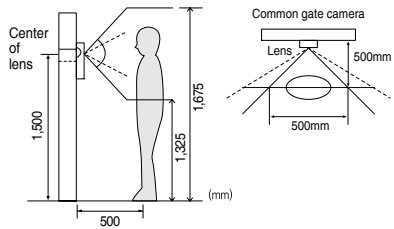

- Standard installation height of common gate camera is 1,400~1,450mm from floor to the bottom of flush mounting box.
- In case that the installation height of common gate camera is out of the range (min. 1,250mm~1,550mm), it's hard to get proper image, so be careful about the installation height of common gate camera.

Caution of camera installation

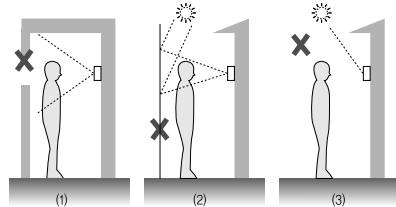

- Avoid installing camera exposed to direct ray of light (and sun).
- Beware backlight and darkness of visitor's face, which makes identification difficult.
- Avoid installing camera in places such as the following picture.
 - (1) Place illuminating sky as background
 - (2) Place with white wall reflecting direct ray of light
 - (3) Place with direct ray of light

※ Keep away from devices generating strong magnetic field (TV, speaker, etc.) (Picture can be disturbed or blurred and breakdown can result)

※ According to outside environment, you may view the images somewhat unclear. However, they do not result from any defect or trouble of the product.

Components

Main body



Concealed box

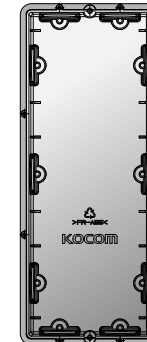

Adaptor (12V/1.5A)

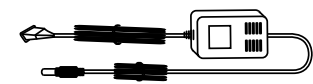

"L" Wrench



I-Button key (Option)



Sun visor (Option)

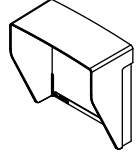

Screws

Wrench screw 2EA



4 pin connector between common gate camera & household monitor

- ④ Yellow } 2 yellow wire : House 2
 - ③ Yellow } : House 2
 - ② Blue } 2 blue wire : House 1
 - ① Blue } : House 1
- (Non-polarity)

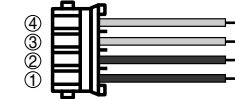

The number of 4pin/2pin connector depends on each model as below.

- KVL-C202i : 2 house - 4pin 1pcs
- KVL-C203i : 3 house - 4pin 1pcs & 2pin 1pcs
- KVL-C204i : 4 house - 4pin 2pcs
- KEL-212 : 12 house - 4pin 6pcs

2 pin connector between common gate camera & household monitor

- ② Yellow } 2 yellow wire : House 1
- ① Yellow } : House 1

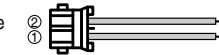

Power input connector between common gate camera & adaptor

1. GND
2. N.C
3. VCC



3pin connector between common gate camera & door opener

1. Yellow : Common
2. Brown : Normal close
3. Black : Normal open



Extension connector between common gate camera & extension unit

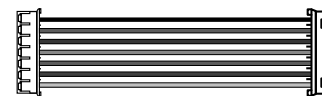

2pin connector between common gate camera & door opener

1. Black : GND
2. Red : +12V



Name of Each Part

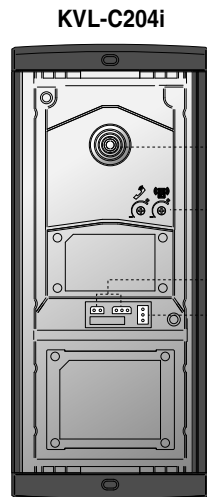
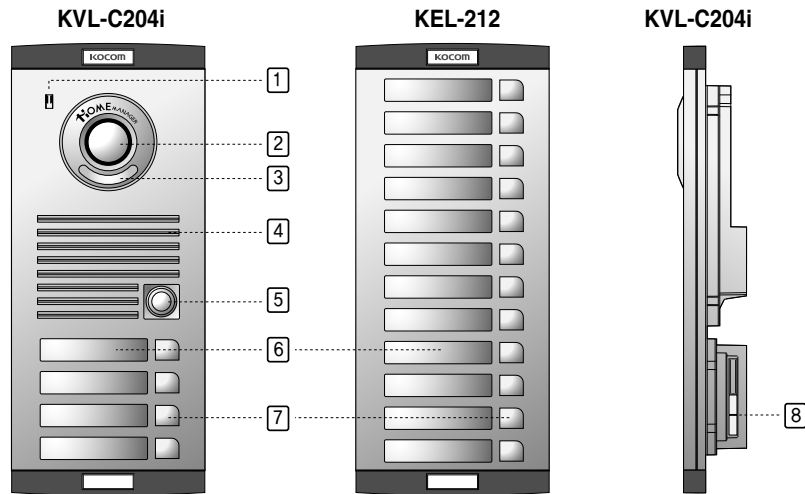

I-Button Key



NO.	Name
1	Microphone
2	Camera lens
3	White LED : Turn on the lights to distinguish objects in the darkness
4	Speaker
5	I-Button probe : Touch with I-Button key to open the door
6	Name indicator : show house information
7	Call button : Press to call and talk to the house
8	House connection terminals
9	Camera angle adjustment by manual
10	Adjust the audio volume ※ Refer to Page.12 'Adjust audio'
11	Terminal for door opener
12	Power input terminal
13	Power & DATA
14	GND

Button & Wiring Information

■ COMMON GATE CAMERA			■ EXTENSION UNIT
KVL-C202i	KVL-C203i	KVL-C204i	KEL-212
2 House	3 House	4 House	12 House

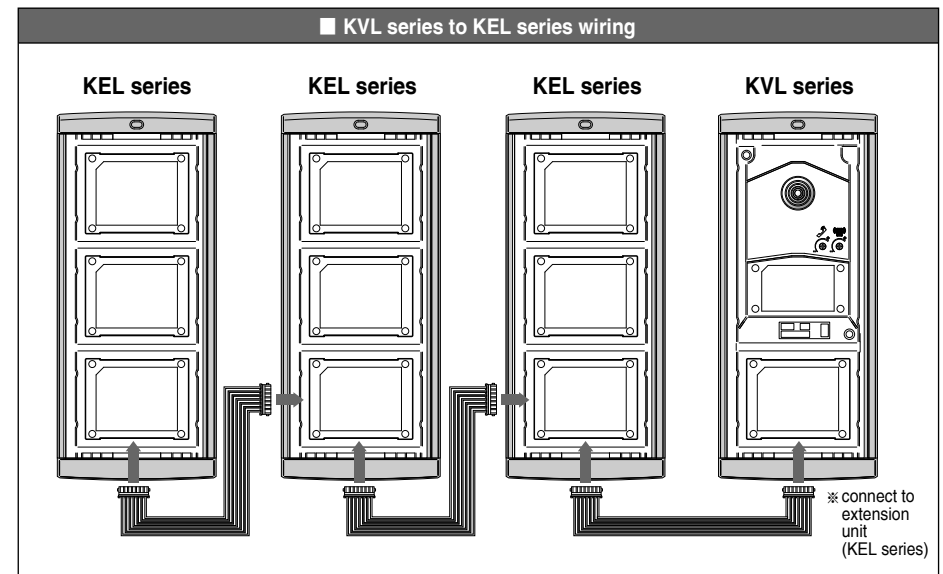

- ※ Can connect upto 12 household using 1 addition common gate camera
- ※ Can connect upto 40 household(max) using 3 addition common gate camera

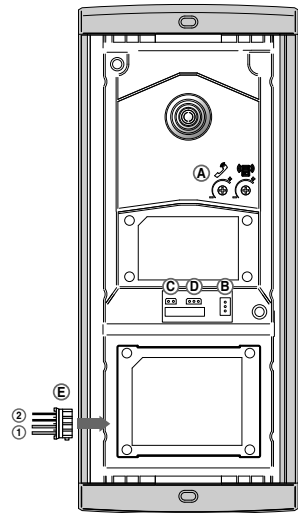

A. Adjust audio

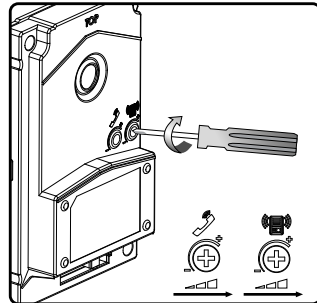

- : Common gate camera → Monitor audio volume
Using a screwdriver, increase(+) or decrease(-) the volume from the Common gate camera to the house
- : Monitor → Common gate camera audio volume
Using a screwdriver, increase(+) or decrease(-) the volume from the house to the Common gate camera

B. POWER INPUT TERMINAL : DC 12V
Additional power supply should be used

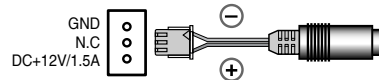

C. Terminal for door opener 1
(Extra adaptor not used)

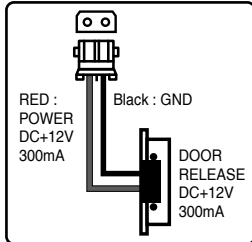

Because the common gate camera supplies the door opener power, 12V 300mA, it is not necessary to install an extra door opener adaptor.

D. Terminal for door opener 2
(Extra adaptor is needed)

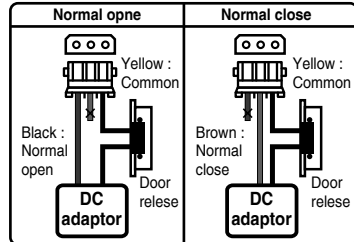

Door opener 2 is output in N.O / N.C and is used in connection in compliance with door release specification.

E. House connection
Terminals consist of 4pin or 8pin wafer

4P Connection between common gate camera & household monitor (Non-polarity)

- ④ Yellow □ 2 yellow wire
- ③ Yellow □ : House 2
- ② Blue □ 2 blue wire
- ① Blue □ : House 1

2P Connection between common gate camera & household monitor

- ① Yellow □ 2 yellow wire
- ① Yellow □ : House 1

※ Connection specification of opening/closing device of the above C, D door is not operated in individual motion. You have to use by selecting one between two specifications.

Common gate camera to monitor 2pin port wiring

- upto 100m : UTP CAT5 cable
- upto 100m : 0.6mm(0.3mm²) Cable
- upto 120m : TIV 0.8mm(0.5mm²) Cable
- upto 150m : TIV 1.0mm(0.8mm²) Cable

KVL-C202i/203i/204i to Household Monitor

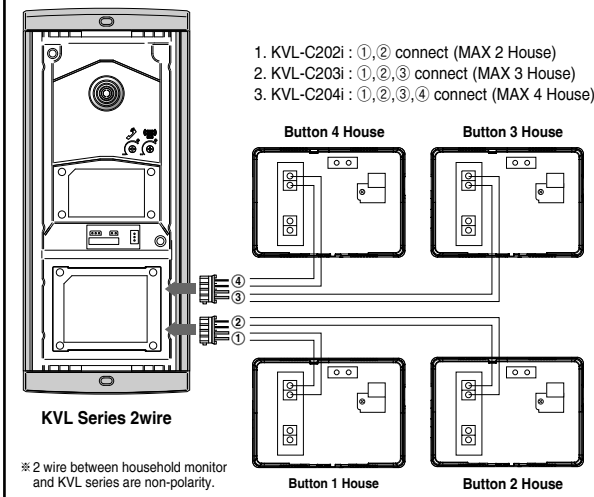

1. KVL-C202i : ①,② connect (MAX 2 House)
2. KVL-C203i : ①,②,③ connect (MAX 3 House)
3. KVL-C204i : ①,②,③,④ connect (MAX 4 House)

※ 2 wire between household monitor and KVL series are non-polarity.

※ Cautions for Installation

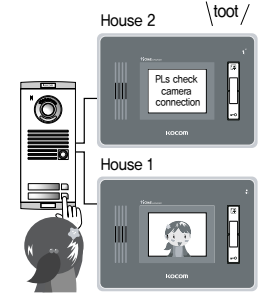

During the monitor installation, if you have 'Pls check camera connection' message on the screen with 'toot-toot' sounds, please turn off the power switch and turn it on after 5 minutes.

This is because you can not do make a connection with the Common gate camera when the communication line between the Common gate camera and any one of the installed monitors is busy.

KEL-212 to Household Monitor

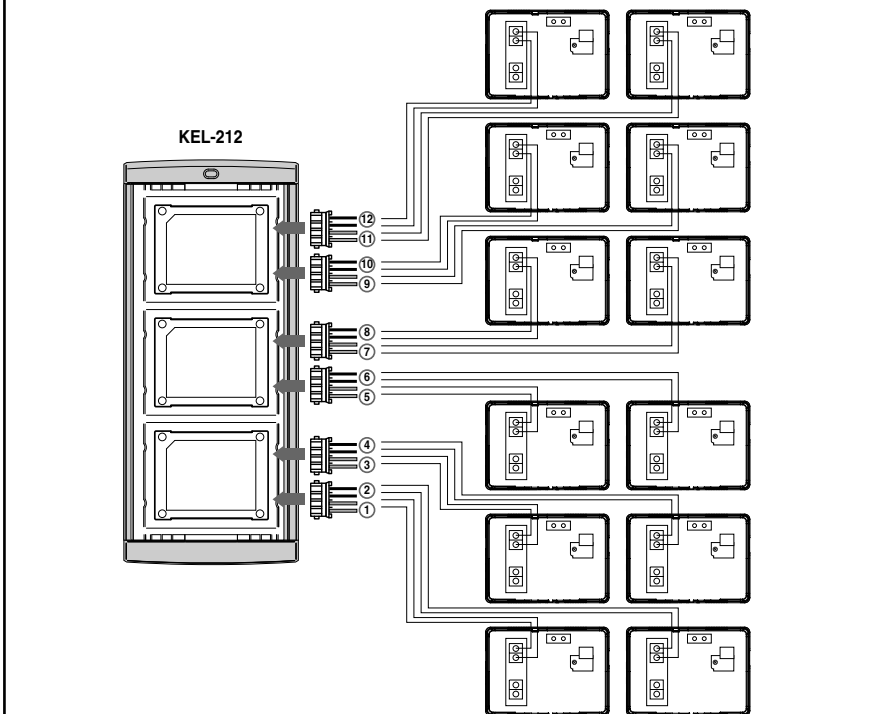

※ 2 wire between household monitor and KEL series are non-polarity.

2 wire Household monitor

Operation Explanation

■ Communication with house monitor

1. When the visitor presses the call button for certain house on the common gate camera, the certain house monitor gets call signal.
2. In case of pressing talk button, the conversation is available.
3. When finishing talk, press talk button once again.

■ Common gate camera from house monitor

1. During conversation with household monitor, if the door open button on the monitor is pressed, the common gate is released, in case the door opener is equipped.
2. Spec of door opener using without power supply : DC 12V / 300mA.

■ Common gate open using I-BUTTON KEY

1. I-BUTTON KEY registered shall contact on I-BUTTON PROBE.
2. Together with transmission of opening buzzer sound of common main entrance door, I-BUTTON LED is lit and common main entrance is opened/closed.

I-BUTTON Registration and Deletion

■ First registration method of I-BUTTON KEY

1. Call household device connected to the common gate camera.
2. Connect call between called household device and common gate camera.
3. I-BUTTON KEY is contacted on I-BUTTON PROBE for 5 seconds.
4. As it is recognized as unregistered I-BUTTON KEY, error sound occurs 5 times consecutively.
5. For 5 seconds, mode entry status is notified in sound.
(Input waiting status notification sound is generated for 10 seconds.)
6. Door opening button is pushed on household device under calling.
(It is registered after recognizing household door opening button.)
7. Buzzer sound advising registration of I-BUTTON KEY after the registration is transmitted.

■ Additional registration method of I-BUTTON KEY

1. Registered I-BUTTON KEY is contacted to I-BUTTON PROBE for 5 seconds.
2. After generation of recognition sound of I-BUTTON KEY, common main entrance door is opened/closed 1 time for the first time.
3. I-BUTTON KEY to register additionally after maintaining contact for 5 seconds is contacted to I-BUTTON PROBE.
4. When I-BUTTON KEY is registered, registration sound is transmitted.

* In case additionally registering I-BUTTON KEY is contacted to I-BUTTON PROBE within 10 seconds under the status of registration, it is registered additionally and registration sound is transmitted.
(When 10 seconds elapse, completion sound becomes in a status of waiting after transmission.)

I-BUTTON Registration and Deletion

※ TACT SWITCH Location

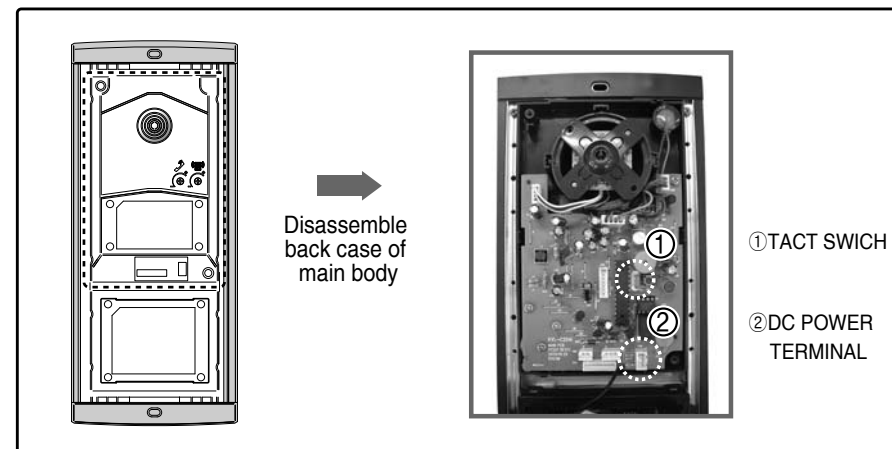

TACT SWITCH is necessary to initialize the Common gate camera and to set door opening time.

※ Only when the power is connected to the Terminal ②, TACT SWITCH is available.

■ Deletion method 1 of the entire I-BUTTON KEY: Not revealed

1. TACT SWITCH of MAIN PBA is pushed 4 times within 2 seconds.
2. During 2 seconds, total deletion buzzer sound is transmitted and total KEY information is deleted to be changed as the initial status.

■ Deletion method 2 of the entire I-BUTTON KEY: Not revealed

1. Two of registered I-BUTTON KEYS are prepared.
2. After calling connected household devices, calls are connected.
3. Under calling status, two KEYS are contacted to I-BUTTON PROBE 4 times in turn during 4 seconds.
4. For 5 seconds, it is entered into mode entry status and buzzer sound is transmitted.
5. For 10 seconds, input waiting status notification buzzer sound is transmitted and within 10 seconds, door opening button of household device connected to calling is pushed.
6. For 2 seconds, total deletion notification sound is generated and stored KEY information is deleted.

■ Set door opening time

1. Under waiting status, TACT SWITCH with in main PBA is pushed for 4 seconds.
2. Currently set door opening time buzzer sound is generated for 0.5 seconds.
3. Once internal PCB button is pushed one time, together with buzzer sound, door opening time is increased per 1 second.

* Do-1 second, Re-2 seconds, Mi-3 seconds, Pa-4 seconds (Basic values), Sol-5 seconds, La-6 seconds, Si-7 seconds, Do-8 seconds (Maximum)

Explanation of I-BUTTON Specification

■ I-BUTTON KEY maximum registration quantity

1. Using EEPROM, maximum up to 1022 are registered.
2. It is impossible to store more than 1022 units and when storage capacity is exceeded, buzzer sound is transmitted for 4 seconds.

*The same I-BUTTON KEY can store and motion but maintains the existing DATA.

Product Specifications

Specifications	KVL series / KEL series
Input power	DC+12V(Un load : 0.9W±20%, In load : 4W±10%)
Communication method	Hands free method (two way)
Run time for call / image	Calls/images maintains for 30 ±3 seconds after call
	Communication with house maintains for 3 minutes ±5 seconds (This time length depends on each model of house monitor)
Exterior material and color	METAL (Zn, Al) / SILVER
Dimensions	125(W) X 290(H) X 48.4(D)mm
Guaranteed operating	-10°C ~ 50°C
Minimum illumination	0.1 Lux (When White LED is turned on)
Camera angle	Diagonal 81°(angle adjustable)

- This product is a Common gate camera connected to 2 wire type products.
It is possible to connect models described in the following.

※ Compatible products

2WIRE VIDEO PHONE : KCV-352/D352, KCV-D372

- EXTENSION UNIT cannot be used without Common gate camera.

In case of BLUE SCREEN

When the visitor makes a wrong call

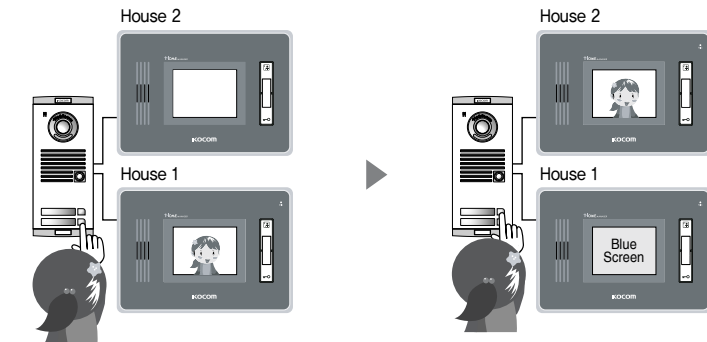

1. The visitor for House 2 presses the wrong House No. 1 button by accident or for several reasons.

2. After that, when the visitor presses again the right House No. 2 button, on the screen of House 1 turns into 'BLUE SCREEN' and automatically turns off after a few seconds.

[Monitoring Condition] When the line is busy

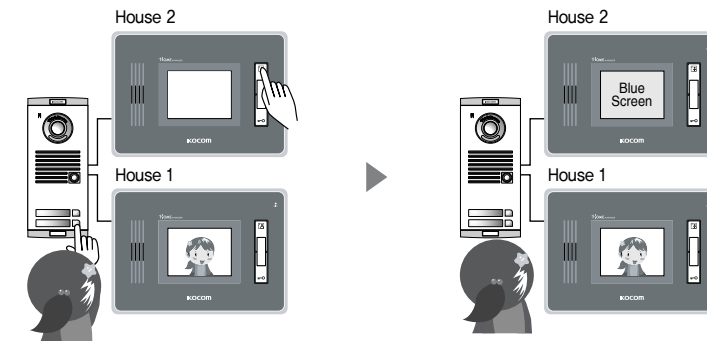

1. The House 1 user is using monitoring function.

2. The House 2 user presses monitoring button when the line is busy. And then on the screen of House 2 turns into 'BLUE SCREEN' and automatically turns off after a few seconds. Please try again.